



**STARLINE**  
*air compressor*

# **PARTES & REFACCIONES**

Marzo 2017





1	Índice
2	Automáticos
3	Manómetros
4	Válvulas check
7	Válvulas de esfera
8	Válvulas de seguridad
9	Purgas
10	Kit de accesorios
11	Válvulas de control
12	Manifolds
13	Arrancadores
14	Poleas tipo "A"
15	Poleas tipo "B"
16	Bandas tipo "A"
17	Bandas tipo "B"
18	Guardabandas
19	Accesorios patas de tanques
20	Refacciones unidades libres de aceite
21	Tubos & mangueras
22	Tuerca terminal
23	Conexión terminal
24	Conexiones roscadas
25	Tapón
25	Aceite para compresor
25	Cuñas & opresores

# AUTOMÁTICOS

STARLINE  
air compressor

## AUTOMÁTICO CON MANIFOLD

MODELO	TIPO	MANIFOLD	VÁLVULA DESAHOGO	RANGO PSI		VOLTAJE	PIEZAS
				ARRANQUE	PARO		
ABBR1	B. ROJO	✓	✓	85	110	110V	1
ABM01	FURNAS	✓	✓	95	125	110V	1 CAJA 50
ABM02	FURNAS	✓	✓	85	115	110V Re- forzado	1
ABM03	FURNAS	✓	✓	105	135	110V Re- forzado	1

Imágenes según tipo:



B. ROJO



FURNAS

## AUTOMÁTICO SIN MANIFOLD

MODELO	TIPO	MANIFOLD	VÁLVULA DESAHOGO	RANGO PSI		VOLTAJE	PIEZAS
				ARRANQUE	PARO		
ABN01	FURNAS	x	✓	85	115	110V	1 CAJA 50
ABN02	FURNAS	x	✓	85	115	110V Re- forzado	1
ABN04	FURNAS	x	x	50	80	110V	1
ABN05	FURNAS	x	✓	145	175	110V Re- forzado	1

Imágenes según válvula de desahogo:



CON



SIN

# MANÓMETROS

Pressure measurement

STARLINE  
air compressor

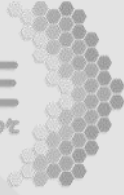

## MANÓMETRO INFERIOR

MODELO	ENTRADA		RANGO	Ø	RÁTULA	CA-	PIEZAS
	TIPO	R					
AMI01	INFERIOR	1/4" NPT	0-160 PSI		2"		1
AMI02	INFERIOR	1/4" NPT	0-180 PSI		2"		1
AMI03	INFERIOR	1/4" NPT	0-200 PSI		2"		1
AMG01	INFERIOR	1/4" NPT	0-160 PSI		2.5" CON GLICERINA		1
AMG02	INFERIOR	1/4" NPT	0-200 PSI		2.5" CON GLICERINA		1



AMI01, AMI02, AMI03



AMG01, AMG02

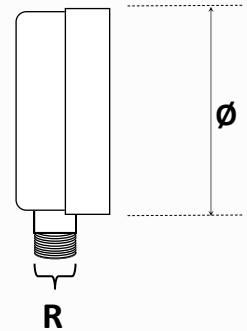

## MANÓMETRO POSTERIOR

MODELO	ENTRADA		RANGO	Ø	RÁTULA	CA-	PIEZAS
	TIPO	R					
AMP03	POSTERIOR	1/4" NPT	0-160 PSI		2"		1
AMP04	POSTERIOR	1/4" NPT	0-200 PSI		2"		1
AMP05	POSTERIOR	1/4" NPT	0-180 PSI		2"		1
AMP06	POSTERIOR	1/8" NPT	0-180 PSI		1.5"		1



TODOS LOS MODELOS

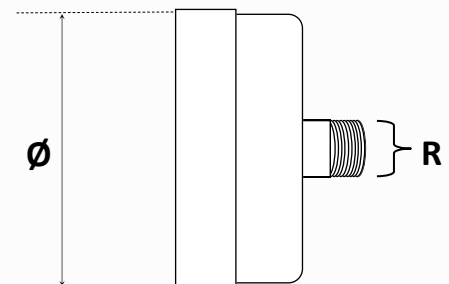

# VÁLVULA CHECK

CHECK VALVE

STARLINE  
air compressor

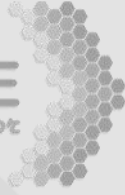

## VÁLVULA CHECK LINEAL **CORTA**

MODELO	TIPO	CONEXIONES			MECANISMO	MATERIAL	ORIGEN	PZS.
		ENTRADA	SALIDA	DESAHOGO				
ADL01	LINEAL	3/8" FLARE	3/8" NPT H	×	PERNO	BRONCE	CHINA	1
ADL02	LINEAL	3/8" FLARE	1/2" NPT M	×	PERNO	BRONCE	CHINA	1
ADL03	LINEAL	3/8" FLARE	1/2" NPT H	×	TEFLON	ALUMINIO	MÉXICO	1
ADL30	LINEAL	3/8" FLARE	1/2" NPT H	×	TEFLON	BRONCE	MÉXICO	1
ADL31	LINEAL	1/2" FLARE	1/2" NPT H	×	TEFLON	BRONCE	MÉXICO	1
ADL32	LINEAL	3/8" FLARE	1/2" NPT H	1/8" NPT H	TEFLON	BRONCE	MÉXICO	1
ADL33	LINEAL	1/2" FLARE	1/2" NPT H	1/8" NPT H	TEFLON	BRONCE	MÉXICO	1



ADL01



ADL02



ADL03



ADL30, ADL31



ADL32, ADL33

## VÁLVULA CHECK LINEAL **MACHO**

MODELO	TIPO	CONEXIONES			MECANISMO	MATERIAL	ORIGEN	PZS.
		ENTRADA	SALIDA	DESAHOGO				
ADL04	LINEAL	3/8" FLARE	1/2" NPT M	1/8" NPT H CON CODO DE 1/8" NPT x 1/4" FLARE	DESARMABLE	BRONCE	CHINA	1
ADL05	LINEAL	≈ 1/2" FLARE ROSCA CHINA	1/2" NPT M	1/8" NPT H CON CODO DE 1/8" NPT x 1/4" FLARE	DESARMABLE	BRONCE	CHINA	1 50
ADL06	LINEAL	1/2" FLARE	1/2" NPT M	1/8" NPT H	ENGRAPADO	BRONCE	USA CONRADER	1
ADL10	LINEAL	3/4" FLARE	3/4" NPT M	1/8" NPT H	ENGRAPADO	BRONCE	USA CONRADER	1
ADL34	LINEAL	3/4" FLARE	3/4" NPT M	1/8" NPT H	DESARMABLE	BRONCE	MÉXICO	1
ADL35	LINEAL	3/4" FLARE	1" NPT M	1/8" NPT H	DESARMABLE	BRONCE	MÉXICO	1



ADL04, ADL05



ADL06, ADL10



ADL34



ADL35

# VÁLVULA CHECK

CHECK VALVE

STARLINE  
air compressor

## VÁLVULA CHECK LINEAL HEMBRA

MODELO	TIPO	CONEXIONES			MECANISMO	MATERIAL	ORIGEN	PZS.
		ENTRADA	SALIDA	DESAHOGO				
ADL08	LINEAL	¾" NPT H	¾" NPT M	⅛" NPT H	DESARMABLE	BRONCE	USA CONRADER	1
ADL09	LINEAL	¾" NPT H	¾" NPT M	⅛" NPT H	ENGRAPADO	BRONCE	USA CONRADER	1
ADL12	LINEAL	¾" NPT H	1" NPT M	⅛" NPT H	DESARMABLE	BRONCE	USA CONRADER	1
ADL13	LINEAL	1" NPT H	1¼" NPT M	⅛" NPT H	DESARMABLE	BRONCE	USA CONRADER	1
ADL40	LINEAL	½" NPT H	½" NPT M	⅛" NPT H	DESARMABLE	BRONCE	MÉXICO	1
ADL41	LINEAL	¾" NPT H	¾" NPT M	⅛" NPT H	DESARMABLE	BRONCE	MÉXICO	1
ADL42	LINEAL	¾" NPT H	1" NPT M	⅛" NPT H	DESARMABLE	BRONCE	MÉXICO	1
ADL43	LINEAL	1" FLARE	1" NPT M	⅛" NPT H	DESARMABLE	BRONCE	MÉXICO	1
ADL44	LINEAL	¾" NPT H	1¼" NPT M	⅛" NPT H	DESARMABLE	BRONCE	MÉXICO	1
ADL45	LINEAL	1" NPT H	1¼" NPT M	⅛" NPT H	DESARMABLE	BRONCE	MÉXICO	1
ADL46	LINEAL	¾" NPT H	1½" NPT M	⅛" NPT H	DESARMABLE	BRONCE	MÉXICO	1
ADL47	LINEAL	1" FLARE	1½" NPT M	⅛" NPT H	DESARMABLE	BRONCE	MÉXICO	1



ADL08, ADL12, ADL13



ADL09



ADL40, ADL41



ADL42, ADL43



ADL44, ADL45



ADL46, ADL47

# VÁLVULA CHECK

CHECK VALVE

STARLINE  
air compressor

## VÁLVULA CHECK ESCUADRA

MODELO	TIPO	CONEXIONES			MECANISMO	MATERIAL	ORIGEN	PZS.
		ENTRADA	SALIDA	DESAHOGO				
ADE01	ESCUADRA	3/8" NPT M	1/2" NPT M	1/4" FLARE	DESARMABLE	ALEACION ZINC	CHINA	1
ADE02	ESCUADRA	≈ 1/2" FLARE ROSCA CHINA	1/2" NPT M	1/8" NPT H CON CODO DE 1/8" NPT x 1/4" FLARE	DESARMABLE	BRONCE	CHINA	1 50
ADE03	ESCUADRA	3/8" FLARE	3/8" NPT M	1/4" FLARE	DESARMABLE	BRONCE	CHINA	1



ADE01



ADE02



ADE03

## VÁLVULA CHECK LINEAL PASO

MODELO	TIPO	CONEXIONES			MECANISMO	MATERIAL	ORIGEN	PZS.
		ENTRADA	SALIDA	DESAHOGO				
ADS01	LINEAL	1/4" NPT M	1/4" NPT M	x	ENGRAPADO	BRONCE	USA CONRADER	1



ADS01

# VÁLVULA DE ESFERA

BALL VALVE

STARLINE  
air compressor

LLAVE DE PASO  
**CONTROL**

MODELO	CONEXIONES		MATERIAL	TIPO	PIEZAS
	E	S			
AJA01	¼" NPT MACHO	¼" NPT MACHO CON ESPIGA DENTADA	ALEACIÓN BRONCE	ESFERA	1 10 50
AJA02	¼" NPT MACHO	¼" NPT MACHO	BRONCE	AGUJA	1
AJA03	¼" NPT MACHO	¼" NPT MACHO	BRONCE	ESFERA	1
AJEP2	¼" NPT MACHO	¼" NPT HEMBRA	BRONCE	AGUJA	1
AJEP3	¼" NPT MACHO	¼" NPT MACHO	BRONCE	CAPUCHON	1
AJE02	¼" NPT HEMBRA	¼" NPT HEMBRA	BRONCE	ESFERA	1
AJE22	½" NPT HEMBRA	½" NPT HEMBRA	BRONCE	ESFERA	1
AJE23	½" NPT MACHO	½" NPT HEMBRA	BRONCE	ESFERA	1
AJE32	¾" NPT HEMBRA	¾" NPT HEMBRA	BRONCE	ESFERA	1
AJE33	¾" NPT MACHO	¾" NPT HEMBRA	BRONCE	ESFERA	1



AJA01



AJA02



AJA03



AJEP2



AJEP3



AJE23, AJE33

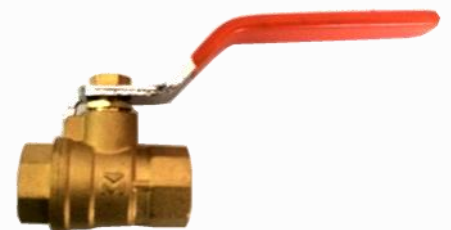
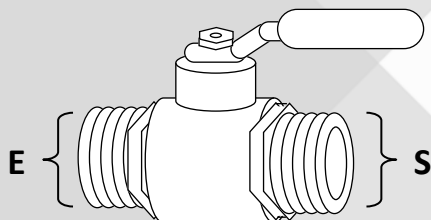

AJE02, AJE22

7 En ocasiones la válvula se encuentra con terminación cromada.



# VÁLVULA DE SEGURIDAD

SAFETY VALVE

STARLINE  
air compressor

## VÁLVULA DE ALIVIO SEGURIDAD

MODELO	CONEXION	PRESION		MATERIAL	ORIGEN	PIEZAS
		MAXIMA	TIPO			
AQR02	1/8" NPT MACHO	75 PSI	AJUSTABLE	BRONCE	CHINA	1
AQR04	1/4" NPT MACHO	75 PSI	AJUSTABLE	BRONCE	CHINA	1
AQS01	1/4" NPT MACHO	120 PSI	AJUSTABLE	BRONCE CON CAPUCHON	CHINA	1
						10
						50
AQS05	1/4" NPT MACHO	125 PSI	SELLADA	BRONCE	USA CONRADER	1
AQS07	1/4" NPT MACHO	200 PSI	SELLADA	BRONCE	USA CONRADER	1
AQS08	1/4" NPT MACHO	150 PSI	SELLADA	BRONCE	USA CONRADER	1
AQS10	1/4" NPT MACHO	200 PSI	AJUSTABLE	BRONCE	CHINA	1
AQW02	1/2" NPT MACHO	200 PSI	SELLADA	BRONCE	USA CONRADER	1



AQR02



AQR04



AQS01, AQS10



AQS05, AQS07



AQW02

# DRAIN VALVE PURGAS

STARLINE  
air compressor

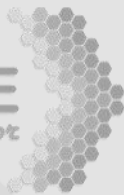

## VÁLVULA DREN PURGAS

MODELO	CONEXION	MATERIAL	PIVOTE	ORIGEN	PIEZAS
AOB01	1/4" NPT MACHO	BRONCE	REDONDO BRONCE	CHINA	1
					10
					50
AOH01	1/4" NPT MACHO	HIERRO CROMADO	REDONDO BRONCE	MÉXICO	1
					10
					50
AOM02	1/4" NPT MACHO	BRONCE	MARIPOSA BRONCE	CHINA	1
					10
					50
AOB02	3/8" NPT MACHO	BRONCE	REDONDO BRONCE	CHINA	1
					10
					50



AOB01, AOB02



AOH01



AOM02

## PURGA AUTOMÁTICA

MODELO	CONEXION	VOLTAJE	INTERVALO DE TRABAJO	TIEMPO DE DRENADO	PRESION MAXIMA DE TRABAJO	ORIGEN	PIEZAS
AOA14	1/4" NPT	127V	0.5-45 MIN.	0.5-10 SEG.	87 PSI	CHINA	1
AOA12	1/2" NPT	127V	0.5-45 MIN.	0.5-10 SEG.	87 PSI	CHINA	1



AOA14



AOA12

# KIT DE ACCESORIOS

STARLINE  
air compressor

ACCESORIOS PARA COMPRESOR

**KIT**

MODELO	INCLUYE			ORIGEN
	ENTRADA	SALIDA	DESAHOGO	
AKFM1	1	ABM01	AUTOMATICO T/FURNAS <b>CON</b> MANIFOLD	CHINA
	1	AMI02	MANOMETRO 0-180 PSI, INFERIOR 1/4"	
	1	ADL05	CHECK 1/2" x 1/2"(ROSC. CHINA) C/TUERCA	
	1	AJA01	LLAVE DE PASO 1/4" x 1/4" DENTADA	
	1	AQS01	VALVULA DE SEGURIDAD 1/4"	
	1	AOB01	PURGA 1/4" BRONCE	
AKFS1	1	ABN01	AUTOMATICO T/FURNAS <b>SIN</b> MANIFOLD	CHINA
	1	AMI02	MANOMETRO 0-180 PSI, INFERIOR 1/4"	
	1	ADL05	Check 1/2" X 1/2"(Rosca. China)c/ tuerca	
	1	AJA01	LLAVE DE PASO 1/4"x 1/4" DENTADA	
	1	AQS01	VALVULA DE SEGURIDAD 1/4"	
	1	AOB01	PURGA 1/4" BRONCE	
AKRM1	1	ABBR1	AUTOMATICO <b>BOTON ROJO</b> CON MANIFOLD	CHINA
	1	AMI02	MANOMETRO 0-180 PSI, INFERIOR 1/4"	
	1	ADL05	Check 1/2" X 1/2"(Rosca. China)c/ tuerca	
	1	AJA01	LLAVE DE PASO 1/4"x 1/4" DENTADA	
	1	AQS01	VALVULA DE SEGURIDAD 1/4"	
	1	AOB01	PURGA 1/4" BRONCE	



AKFM1



AKFS1



AKRM1



# VÁLVULA DE CONTROL

STARLINE  
air compressor

## VÁLVULA DE CONTROL CONRADER

MODELO	CONEXION	MATERIAL	ORIGEN	PIEZAS
ATD01	<ul style="list-style-type: none"> <li>• DESCARGA PILOTO 1/2"</li> <li>• CHECK</li> </ul>	BRONCE	USA CONRADER	1
ATD02	<ul style="list-style-type: none"> <li>• DESCARGA PILOTO 3/4"</li> <li>• CHECK</li> </ul>	BRONCE	USA CONRADER	1
ATP01	DESCARGA PILOTO	BRONCE	USA CONRADER	1
ATC01	PISTON EXTRANGULADOR, CON CHICOTE DE 42"	BRONCE	USA CONRADER	1
ADA02	VALVULA ARRANCAMOTOR	BRONCE	USA CONRADER	1

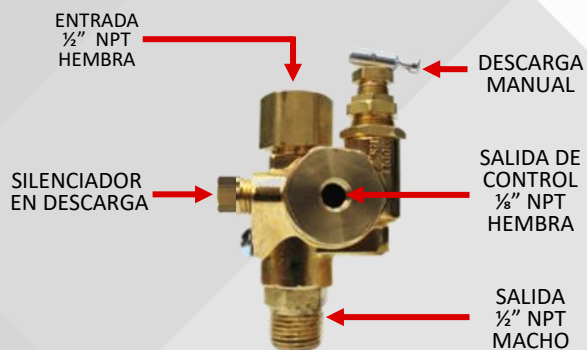

ATD01

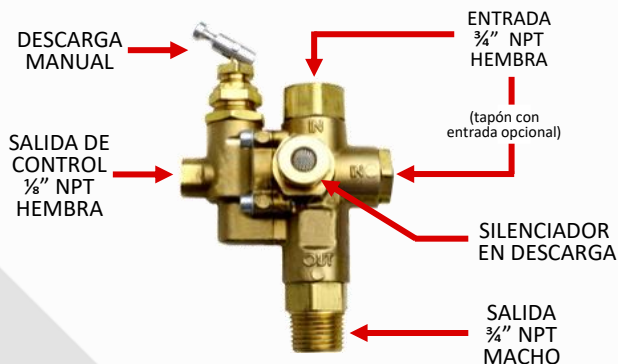

ATD02

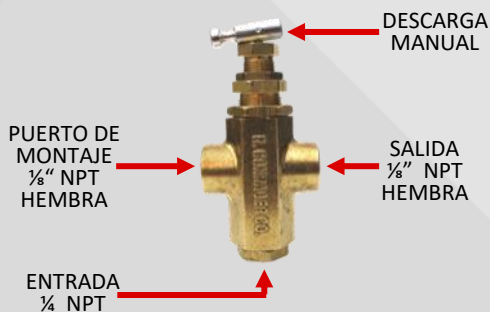

ATP01



ATC01

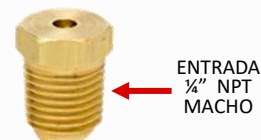

ADA02

# MANIFOLDS

STARLINE  
air compressor

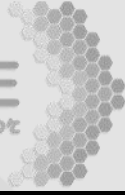

## MANIFOLD CONECTIVIDAD

MODELO	TAMAÑO			PIEZAS	PIEZAS
	INFERIOR	SUPERIOR	LATERALES		
AHH01	½" NPT HEMBRA	¼" NPT HEMBRA	2 SALIDAS DE ¼" NPT HEMBRA	HIERRO	1
AHH02	½" NPT HEMBRA	¼" NPT HEMBRA	3 SALIDAS DE ¼" NPT HEMBRA	HIERRO	1
AHH04	¾" NPT HEMBRA	¼" NPT HEMBRA	2 SALIDAS DE ½" NPT HEMBRA 1 SALIDAS DE ¼" NPT HEMBRA	ALUMINIO	1



AHH01, AHH02



AHH04

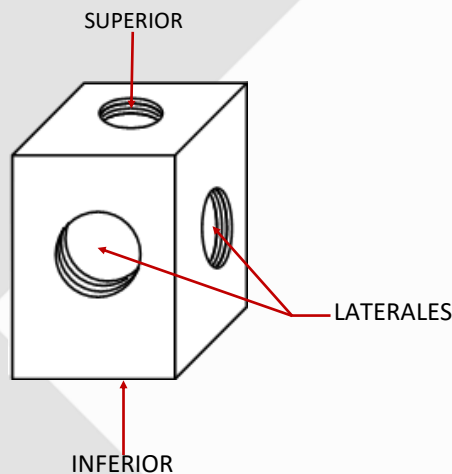

# ARRANCADOR A TENSIÓN PLENA

STARLINE  
air compressor

## ARRANCADOR TERMOMAGNÉTICO PROTECTOR

MODELO	MARCA	RANGO AMPERAJE	VOLTAJE	GABINETE	FUNCIONA CON MOTORES DE	PIEZAS
AAP01	WEILEITE	7-11 AMP	220 V	METALICO	• 3HP TRIF.	1
AAP02	WEILEITE	12-18 AMP	220 V	METALICO	• 5HP TRIF. • 3HP BIF.	1
AAP03	WEILEITE	24-34 AMP	220 V	METALICO	• 10HP TRIF. • 5HP BIF.	1
AAW01	WEG	7-10 AMP	220 V	PLASTICO	• 3HP TRIF.	1
AAW02	WEG	12-17 AMP	220 V	PLASTICO	• 5HP TRIF. • 3HP BIF.	1
AAW03	WEG	5.6-8 AMP	440 V	PLASTICO	• 5HP TRIF. 440V	1
AAW04	WEG	16-23 AMP	220 V	PLASTICO	• 7.5HP TRIF.	1
AAW05	WEG	22-32 AMP	220 V	PLASTICO	• 10HP TRIF. • 5HP BIF.	1
AAW06	WEG	11-17 AMP	440 V	PLASTICO	• 10HP TRIF. 440V	1
AAW07	WEG	32-50 AMP	220 V	PLASTICO	• 15HP TRIF.	1
AAW08	WEG	60-63 AMP	220 V	PLASTICO	• 20HP TRIF.	1

Imágenes según marca:



WEILEITE



WEG

MODELO	MARCA	PIEZAS
AAX01	PREPARACION DE ARRANCADOR CON PLACA METALICA DE MONTAJE Y CABLES	1



AAX01



# PULLEY POLEA

STARLINE  
air compressor

## POLEA DE ALUMINIO UNA RANURA

MODELO	Ø	RANURA		Ø FLECHA *	CUÑERO	ROSCA OPRESOR	PIEZAS
		CANTIDAD	TIPO				
ANP20	2"	1	A	5/8"	3/16"	5/16"	1
ANP25	2.5"	1	A	5/8"	3/16"	5/16"	1
ANP30	3"	1	A	5/8"	3/16"	5/16"	1
ANP35	3.5"	1	A	5/8"	3/16"	5/16"	1
ANP40	4"	1	A	5/8"	3/16"	5/16"	1
ANP45	4.5"	1	A	5/8"	3/16"	5/16"	1
ANP50	5"	1	A	5/8"	3/16"	5/16"	1
ANP55	5.5"	1	A	5/8"	3/16"	5/16"	1
ANP60	6"	1	A	5/8"	3/16"	5/16"	1
ANP65	6.5"	1	A	5/8"	3/16"	5/16"	1
ANP70	7"	1	A	5/8"	3/16"	5/16"	1
ANP80	8"	1	A	5/8"	3/16"	5/16"	1
ANR20	2"	1	B	5/8"	3/16"	5/16"	1
ANR25	2.5"	1	B	5/8"	3/16"	5/16"	1
ANR30	3"	1	B	5/8"	3/16"	5/16"	1
ANR35	3.5"	1	B	5/8"	3/16"	5/16"	1
ANR40	4"	1	B	5/8"	3/16"	5/16"	1
ANR45	4.5"	1	B	5/8"	3/16"	5/16"	1
ANR50	5"	1	B	5/8"	3/16"	5/16"	1
ANR55	5.5"	1	B	5/8"	3/16"	5/16"	1
ANR60	6"	1	B	5/8"	3/16"	5/16"	1
ANR65	6.5"	1	B	5/8"	3/16"	5/16"	1
ANR70	7"	1	B	5/8"	3/16"	5/16"	1
ANR80	8"	1	B	5/8"	3/16"	5/16"	1

DISPONIBLES EN OTRAS MEDIDAS DE FLECHA Y CUÑERO

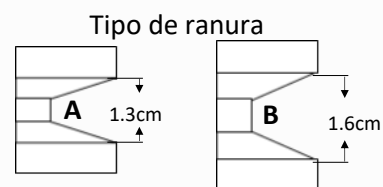
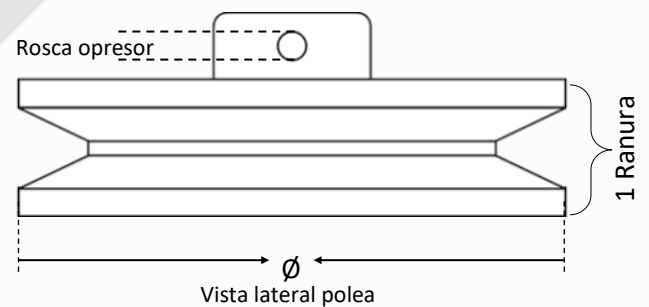
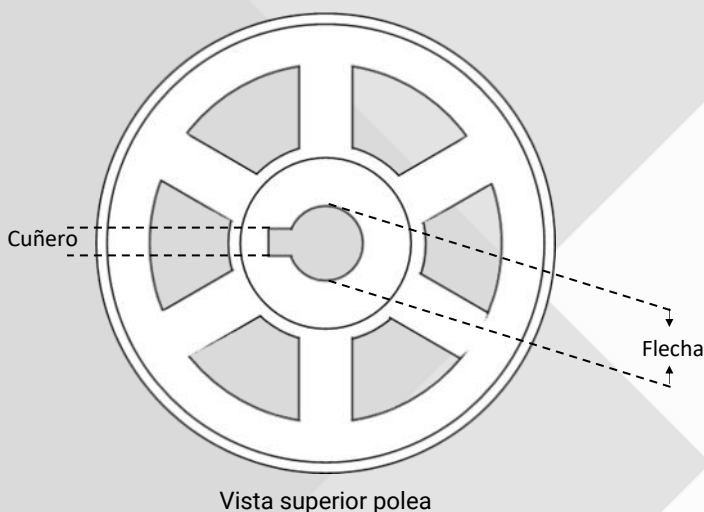

# PULLEY POLEA

STARLINE  
air compressor

## POLEA DE ALUMINIO DOS RANURAS

MODELO	Ø	RANURA		Ø FLECHA *	CUÑERO	ROSCA OPRESOR	PIEZAS
		CANTIDAD	TIPO				
ANQ20	2"	2	A	5/8"	3/16"	5/16"	1
ANQ25	2.5"	2	A	5/8"	3/16"	5/16"	1
ANQ30	3"	2	A	5/8"	3/16"	5/16"	1
ANQ35	3.5"	2	A	5/8"	3/16"	5/16"	1
ANQ40	4"	2	A	5/8"	3/16"	5/16"	1
ANQ45	4.5"	2	A	5/8"	3/16"	5/16"	1
ANQ50	5"	2	A	5/8"	3/16"	5/16"	1
ANQ55	5.5"	2	A	5/8"	3/16"	5/16"	1
ANQ60	6"	2	A	5/8"	3/16"	5/16"	1
ANQ65	6.5"	2	A	5/8"	3/16"	5/16"	1
ANQ70	7"	2	A	5/8"	3/16"	5/16"	1
ANQ80	8"	2	A	5/8"	3/16"	5/16"	1
ANS20	2"	2	B	5/8"	3/16"	5/16"	1
ANS25	2.5"	2	B	5/8"	3/16"	5/16"	1
ANS30	3"	2	B	5/8"	3/16"	5/16"	1
ANS35	3.5"	2	B	5/8"	3/16"	5/16"	1
ANS40	4"	2	B	5/8"	3/16"	5/16"	1
ANS45	4.5"	2	B	5/8"	3/16"	5/16"	1
ANS50	5"	2	B	5/8"	3/16"	5/16"	1
ANS55	5.5"	2	B	5/8"	3/16"	5/16"	1
ANS60	6"	2	B	5/8"	3/16"	5/16"	1
ANS65	6.5"	2	B	5/8"	3/16"	5/16"	1
ANS70	7"	2	B	5/8"	3/16"	5/16"	1
ANS75	7.5"	2	B	5/8"	3/16"	5/16"	1
ANS80	8"	2	B	5/8"	3/16"	5/16"	1
ANS85	8.5"	2	B	5/8"	3/16"	5/16"	1

**DISPONIBLES EN OTRAS MEDIDAS DE FLECHA Y CUÑERO**

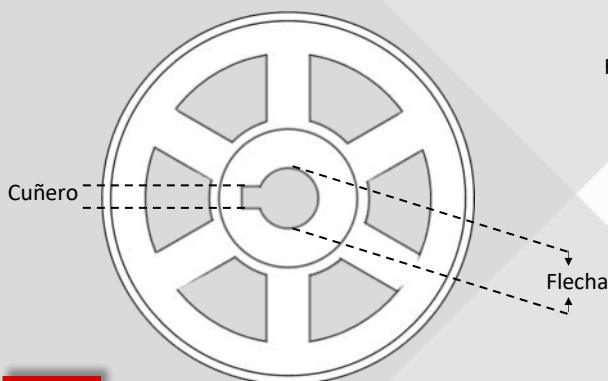

Vista superior polea

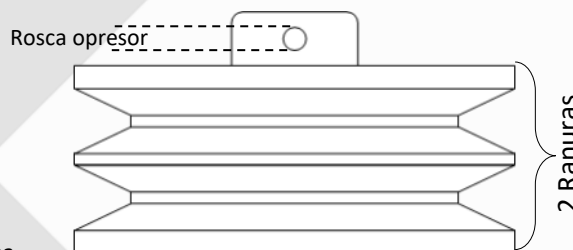

Vista lateral polea

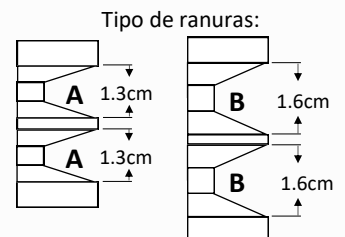

# BELT BANDAS

STARLINE  
air compressor

## BANDA TIPO "A"

MODELO	TIPO	LONGITUD
ACA22	A	22
ACA23	A	23
ACA24	A	24
ACA25	A	25
ACA26	A	26
ACA27	A	27
ACA28	A	28
ACA29	A	29
ACA30	A	30
ACA31	A	31
ACA32	A	32
ACA33	A	33
ACA34	A	34
ACA35	A	35
ACA36	A	36
ACA37	A	37
ACA38	A	38
ACA39	A	39
ACA40	A	40
ACA41	A	41
ACA42	A	42
ACA43	A	43
ACA44	A	44
ACA45	A	45
ACA46	A	46
ACA47	A	47
ACA48	A	48
ACA49	A	49
ACA50	A	50
ACA51	A	51
ACA52	A	52
ACA53	A	53
ACA54	A	54
ACA55	A	55
ACA56	A	56
ACA57	A	57
ACA58	A	58
ACA59	A	59

MODELO	TIPO	LONGITUD
ACA60	A	60
ACA61	A	61
ACA62	A	62
ACA63	A	63
ACA64	A	64
ACA65	A	65
ACA66	A	66
ACA67	A	67
ACA68	A	68
ACA69	A	69
ACA70	A	70
ACA71	A	71
ACA72	A	72
ACA73	A	73
ACA74	A	74
ACA75	A	75
ACA76	A	76
ACA77	A	77
ACA78	A	78
ACA79	A	79
ACA80	A	80
ACA81	A	81
ACA82	A	82
ACA83	A	83
ACA84	A	84
ACA85	A	85
ACA86	A	86
ACA87	A	87
ACA88	A	88
ACA89	A	89
ACA90	A	90
ACA91	A	91
ACA92	A	92

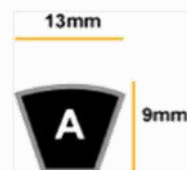



# BELT BANDAS

STARLINE  
air compressor

## BANDA TIPO "B"

MODELO	TIPO	LONGITUD
ACB30	B	30
ACB31	B	31
ACB32	B	32
ACB33	B	33
ACB34	B	34
ACB35	B	35
ACB36	B	36
ACB37	B	37
ACB38	B	38
ACB39	B	39
ACB40	B	40
ACB41	B	41
ACB42	B	42
ACB43	B	43
ACB44	B	44
ACB45	B	45
ACB46	B	46
ACB47	B	47
ACB48	B	48
ACB49	B	49
ACB50	B	50
ACB51	B	51
ACB52	B	52
ACB53	B	53
ACB54	B	54
ACB55	B	55
ACB56	B	56
ACB57	B	57
ACB58	B	58
ACB59	B	59
ACB60	B	60
ACB61	B	61
ACB62	B	62
ACB63	B	63
ACB64	B	64
ACB65	B	65
ACB66	B	66
ACB67	B	67

MODELO	TIPO	LONGITUD
ACB68	B	68
ACB69	B	69
ACB70	B	70
ACB71	B	71
ACB72	B	72
ACB73	B	73
ACB74	B	74
ACB75	B	75
ACB76	B	76
ACB77	B	77
ACB78	B	78
ACB79	B	79
ACB80	B	80
ACB81	B	81
ACB82	B	82
ACB83	B	83
ACB84	B	84
ACB85	B	85
ACB86	B	86
ACB87	B	87
ACB88	B	88
ACB89	B	89
ACB90	B	90
ACB91	B	91
ACB92	B	92
ACB93	B	93
ACB94	B	94
ACB95	B	95
ACB96	B	96
ACB97	B	97
ACB98	B	98
ACB99	B	99
ACB100	B	100

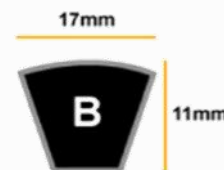

BELT GUARD

# GUARDABANDA

STARLINE  
air compressor

## GUARDABANDA PROTECTORA SEGURIDAD

MODELO	MATERIAL	TIPO		PIEZAS
		TIPO	TANQUE	
AG050	METAL	1/2	48 ℓ	1
AG075	METAL	3/4	72 ℓ	1
AG100	METAL	1, 1.5	72 ℓ, 108 ℓ, 150 ℓ	1
AG200	METAL	2	108 ℓ, 150 ℓ, 235 ℓ, 300 ℓ	1
AG300	METAL	3	235 ℓ, 300 ℓ	1
AG503	METAL	5	300 ℓ	1
AG505	METAL	5	500 ℓ	1
AG105	METAL	10	500 ℓ	1
AG101	METAL	10	1000 ℓ	1

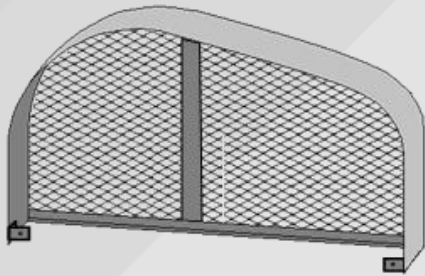

AG050, AG075, AG100

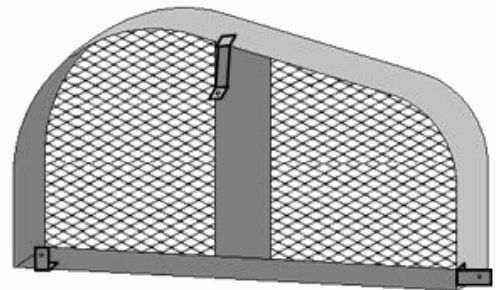

AG300, AG105, AG101

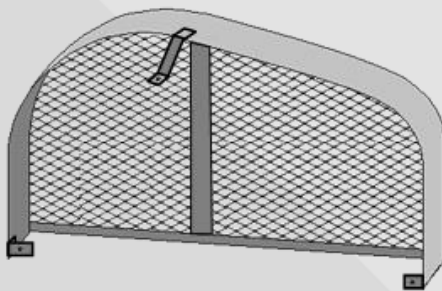

AG050, AG075, AG100

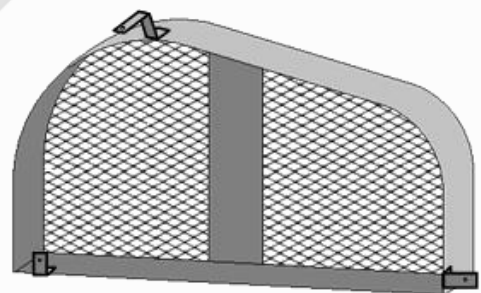

AG050, AG075, AG100

# ACCESORIO PATAS DE TANQUES

STARLINE  
air compressor

## BARROTE DE MADERA **ESTABILIDAD**

MODELO	TAMAÑO			PIEZAS	PIEZAS
	LARGO	GROSOR	ANCHO		
TAD06	60 cm.	2"	4"	150, 235 Y 300 LITROS VERTICAL	1 PAR
TAD09	90 cm.	2"	4"	500 Y 1000 LITROS VERTICAL	1 PAR
TAD12	120 cm.	2"	4"	235 Y 300 LITROS HORIZONTAL	1 PAR
TAD18	180 cm.	2"	4"	500 Y 1000 LITROS HORIZONTAL	1 PAR
TAG06	60 cm.	3"	4"	150, 235 Y 300 LITROS VERTICAL	1 PAR
TAG09	90 cm.	3"	4"	500 Y 1000 LITROS VERTICAL	1 PAR
TAG12	120 cm.	3"	4"	235 Y 300 LITROS HORIZONTAL	1 PAR
TAG18	180 cm.	3"	4"	500 Y 1000 LITROS HORIZONTAL	1 PAR



Imagen ilustrativa.

## RODAJAS Y HULES **MOVILIDAD**

MODELO	DIAMETRO	MATERIAL	ENTRADA	RIN	PIEZAS
ARL06	6"	HULE	5/8"	METALICO	1 PAR
ARL07	7"	HULE	5/8"	METALICO	1 PAR
ART02	2"	HULE	1/4"	NO APLICA	1



ARL06, ARL07



ART02



# REFACCION UNIDADE LIBRE DE ACEITE

STARLINE  
air compressor

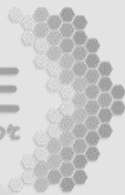

**OIL FREE**

MODELO	TIPO	DESCRIPCION	PARA UNIDAD	PIEZAS
AWU01	VALVULA SOLENOIDE	3V1-06, 110V, 5.5A, 0~10kgf/cm <sup>2</sup>	ULA10 ULA20	1
AWU02	CAPACITOR	80µf, 250V, 70° máx. NORMAL, DE TRABAJO	ULA10	1
AWU03	CAPACITOR	150µf, 250V, 70° máx. NORMAL, DE TRABAJO	ULA20	1
AWU05	INTERRUPTOR TERMINCO	20A, 250V	ULA10	1
AWU06	INTERRUPTOR TERMINCO	30A, 250V	ULA20	1
AWU10	KIT DE REPARACION 1 PISTON	8 PIEZAS: 1 CAMISA, 1 ANILLO, 1 EMPAQUE METAICO, 2 EMPAQUES DE HULE, 1 BASE PISTON y 2 VALVULA FLAPPER	ULA10	1 PAQUETE
AWU11	KIT DE EMPAQUES	6 PIEZAS: 2 EMPAQUE TAPA DEL CILINDRO, 2 EMPAQUE DEL CILINDRO Y 2 O-RING	ULA10	1 PAQUETE
AWU21	KIT DE EMPAQUES	6 PIEZAS: 2 EMPAQUE TAPA DEL CILINDRO, 2 EMPAQUE DEL CILINDRO Y 2 O-RING	ULA20	1 PAQUETE
AWU12	ANILLO PISTON	Ø INTERIOR: 48mm. Ø EXTERIOR: 68mm.	ULA10	1
AWU22	ANILLO PISTON	Ø INTERIOR: 56mm. Ø EXTERIOR: 75mm.	ULA20	1



AWU01



AWU05, AWU06



AWU02, AWU03

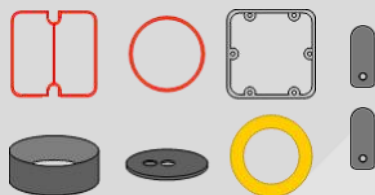

AWU10



AWU11, AWU21

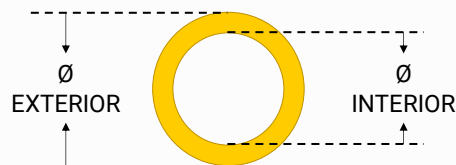

AWU12, AWU22

# TUBOS & MANGUERAS

PIPE & HOSE

STARLINE  
air compressor

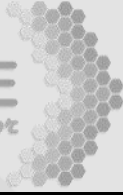

## TUBO DE COBRE FLEXIBLE **COBRE**

MODELO	MATERIAL	MEDIDA	UNIDAD
ANS14	COBRE	1/4"	CENTÍMETRO
ANS38	COBRE	3/8"	CENTÍMETRO
ANS12	COBRE	1/2"	CENTÍMETRO
ANS58	COBRE	5/8"	CENTÍMETRO
ANS34	COBRE	3/4"	CENTÍMETRO



## MANGUERA **SYNFLEX**

MODELO	MATERIAL	MEDIDA	UNIDAD
ATU14	SYNFLEX	1/4"	CENTÍMETRO



TERMINAL NUT

STARLINE  
air compressor

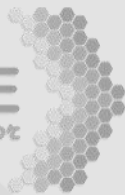

# TUERCA TERMINAL

## TUERCA TERMINAL TUERCA

MODELO	MATERIAL	TIPO	ROSCA	PARA TUBO	PIEZAS
AEX04	HIERRO	CONICA RECORTADA	3/8" FLARE	3/8"	1
AET02	BRONCE	CONICA	1/4" FLARE	1/4"	1
AET04	BRONCE	CONICA	3/8" FLARE	3/8"	1
AET05	BRONCE	CONICA	1/2" FLARE	1/2"	1
AEX06	HIERRO	CONICA	5/8" FLARE	5/8"	1
AET06	BRONCE	CONICA	5/8" FLARE	5/8"	1
AEX07	HIERRO	CONICA	3/4" FLARE	3/4"	1
AET07	BRONCE	CONICA	3/4" FLARE	3/4"	1
AER08	HIERRO	TERMINAL	1/2" ROSCA CHINA	1/2"	1
AER08-10P					10
AER05	HIERRO	TERMINAL	1/2" FLARE	1/2"	1
AER05-10P					10
AES18	HIERRO	TERMINAL REDUCIDA	1/2" ROSCA CHINA	3/8"	1
AES18-10P					10
AES08	HIERRO	TERMINAL REDUCIDA	1/2" FLARE	3/8"	1
AES08-10P					10



AEX04



AET02, AET04,  
AET05, AET06,  
AET07



AEX06, AEX07

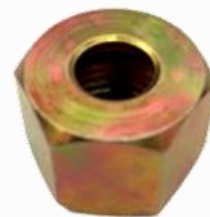

AER08, AER05,  
AES18, AES08

# CONEXIÓN TERMINAL

STARLINE  
air compressor

## CONEXIÓN TERMINAL TERMINAL

MODELO	MATERIAL	TIPO	ROSCA	PIEZAS
AYF02	BRONCE	ADAPTADOR	1/8" NPT MACHO x ANILLO 1/4"	1
AZF02	BRONCE	TEE ADAPTADOR	3 SALIDAS EN ANILLOS 1/4"	1
AEJ02	BRONCE	CODO TERMINAL	1/8" NPT MACHO x 1/4" FLARE C/ TUERCA	1
AEF02	BRONCE	NIPLE TERMINAL	1/8" NPT MACHO x 1/4" FLARE	1
AEG22	HIERRO	NIPLE TERMINAL	1/2" NPT MACHO x 5/8" FLARE	1
AEF22	BRONCE	NIPLE TERMINAL	1/2" NPT MACHO x 5/8" FLARE	1
AEG30	HIERRO	NIPLE TERMINAL	3/4" NPT MACHO x 3/4" FLARE	1
AEF30	BRONCE	NIPLE TERMINAL	3/4" NPT MACHO x 3/4" FLARE	1
AEK22	BRONCE	CODO TERMINAL	1/2" NPT MACHO x 5/8" FLARE	1
AEK30	BRONCE	CODO TERMINAL	3/4" NPT MACHO x 3/4" FLARE	1



AYF02



AZF02



AEJ02



AEF02



AEG22, AEF22,  
AEG30, AEF30



AEK22, AEK30



# CONEXIÓN ROSCADA

STARLINE  
air compressor

## CONEXIÓN ROSCADA CONEXIÓN

MODELO	MATERIAL	TIPO	ROSCA	PIEZAS
APX21	HIERRO	NIPLE HEXAGONAL	1/8" NPT MACHO x 1/8" NPT MACHO	1
APX22	HIERRO	NIPLE HEXAGONAL	1/4" NPT MACHO x 1/4" NPT MACHO	1
AFZ01	HIERRO	ADAPTADOR	1/4" NPT HEMBRA x 1/4" NPT MACHO	1
IFCH2	HIERRO	COPLER HEXAGONAL	1/4" NPT HEMBRA x 1/4" NPT HEMBRA	1
APC01	BRONCE	COPLER	1/8" NPT HEMBRA x 1/8" NPT HEMBRA	1
APW03	BRONCE	REDUCCION	1/2" NPT MACHO x 1/4" NPT MACHO	1
AKE65	ZAMAK	CODO	3/8" NPT MACHO x 3/8" NPT MACHO	1
APL51	BRONCE	CODO	1/8" NPT HEMBRA x 1/8" NPT MACHO	1
AP102	BRONCE	NIPLE	1/4" NPT MACHO x 2.5"	1
AP100	BRONCE	NIPLE	1/4" NPT MACHO x 1.5"	1
APE02	BRONCE	CRUZ	TODAS DE 1/4" NPT HEMBRA	1
APZ02	BRONCE	TEE	TODAS DE 1/4" NPT HEMBRA	1



APX21, APX22



AFZ01



IFCH2



APC01



APW03



AKE65



APL51



AP100, AP102



APE02



APZ02

# VARIOS

STARLINE  
air compressor

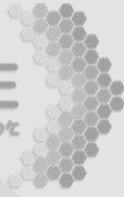

## TAPON ROSCADO MACHO TAPÓN

MODELO	MATERIAL	TIPO	ROSCA	PIEZAS
IFT18	TAPON	1/8" NPT MACHO	HIERRO	1
IFT18-50P				50
IFT18-100P				100



IFT18

## LUBRICANTE PARA COMPRESOR ACEITE

MODELO	TIPO	PRESENTACIÓN
JDP01	PROLUB, PROSOL	LITRO
JDP01-G	A - ISO VG100	GALON



JDP01



JDP01-G

## CUÑAS & POLEAS SEGURIDAD

MODELO	MATERIAL	TIPO	ROSCA	PIEZAS
IH316	CUÑA	1/4"	1¼ APROX.	1
JG051	OPRESOR	5/16"	3/8"	1
JG038	OPRESOR	3/8"	1/2"	1



IH316



JG051, JG038

Conoce todos nuestros

# Productos

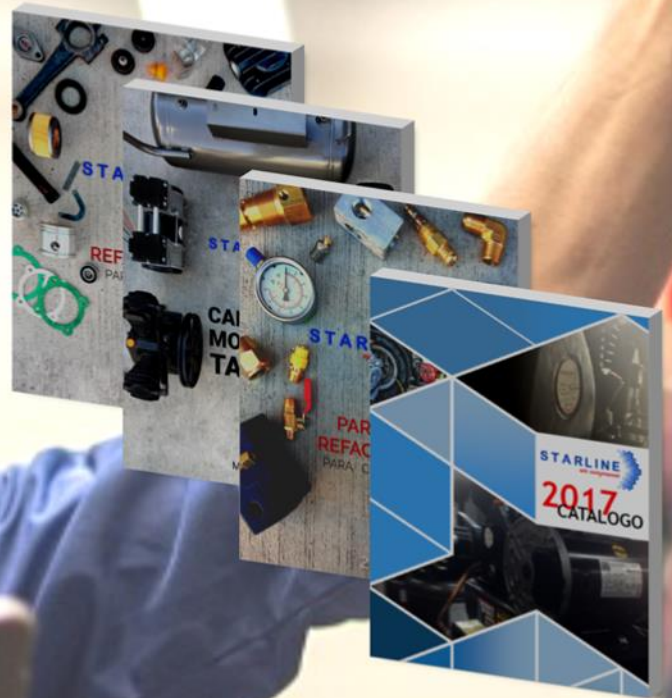

Y visualízalos desde tu  
tablet, móvil o PC

cuando y donde tú quieras

descargando los catálogos en  
[www.starline.com.mx](http://www.starline.com.mx)

**STARLINE**  
*air compressor*





**STARLINE**

*air compressor*



**Starline air compressor, S.A. de C.V.**

Jose Sixto Verduzco No. 83, Col. El retiro,

C.P.: 44280, Guadalajara, Jal. México

Tel.: +52 (33) 3613 9948

ventas@starline.com.mx

**[www.starline.com.mx](http://www.starline.com.mx)**