



STARLINE
air compressor

**REFACCIONES
PARA CABEZAL**

Marzo 2017

Índice

STARLINE
air compressor



- 1 Índice
- 2 Bielas
- 3 Cigüeñal
- 4 Pistón
- 5 Anillos
- 6 Metales
- 6 Pernos
- 7 Baleros
- 7 Retenes
- 8 Válvulas flapper
- 9 Válvulas de admisión y descarga
- 9 Tapa de cilindro
- 10 Filtros de admisión
- 11 Elementos para filtro
- 12 Mirillas
- 13 Tapones de aceite
- 14 Respiraderos
- 15 Empaques para cabezales "TB"
- 16 Empaques para cabezales "TX"
- 17 Volantes para cabezal
- 18 Tubo de enfriamiento
- 18 Válvula de desahogo

PARTES PARA CABEZAL

Air pump spare parts

STARLINE
air compressor

CONNECTING ROD BIELA

MODELO	DIMENSIONES			MATERIAL	APTO PARA CABEZAL	PIEZAS
	D1	L	D2			
TRB07	22	79	14.5	ALUMINIO	ALGUNOS TB03S	1
TRB01	22	79	12.7	ALUMINIO	ALGUNOS TB03S	1
TRB02	24	102	12.7	ALUMINIO	TB10S	1
TRB03	30	108	12.7	ALUMINIO	TB20S	1
TRB04	30	108	14.5	ALUMINIO	TB30S	1
TRB05	32	137	15	ALUMINIO	TB50S	1
TRB06	43.5	178.5	19	Fo. Fo.	TX50C, TX100S	1*



TRB07



TRB01



TRB02



TRB03



TRB04



TRB05



TRB06

*No incluye metales.

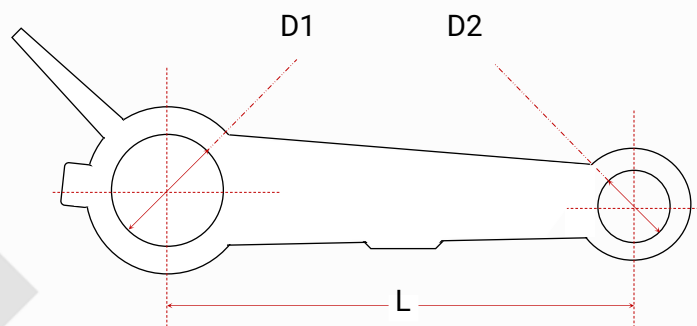

PARTES PARA CABEZAL

Air pump spare parts

STARLINE
air compressor

CRANKSHAFT
CIGÜEÑAL

MODELO	DIMENSIONES				MATERIAL	APTO PARA CABEZAL	PIEZAS
	D1	D2	D3	L			
TRC01	20	20	22	141	Fo. Fo.	TB03S	1
TRC02	20	25	24	208	Fo. Fo.	TB10S	1
TRC03	25	20	30	217	Fo. Fo.	TB20S, TB30S	1
TRC04	35	20	32	256	Fo. Fo.	TB50S	1
TRC05	40	35	40	370	Fo. Fo.	TX50C*	1
TRC06	40	35	40	407	Fo. Fo.	TX100S*	1

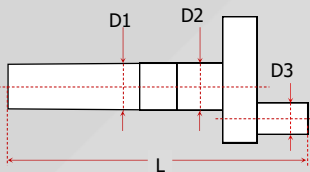

TRC01

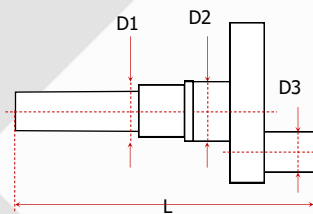

TRC02

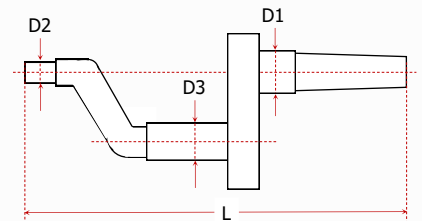

TRC03

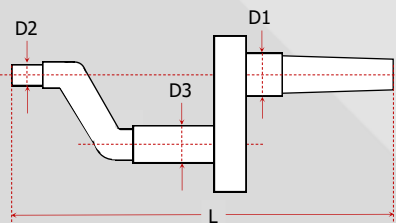

TRC04

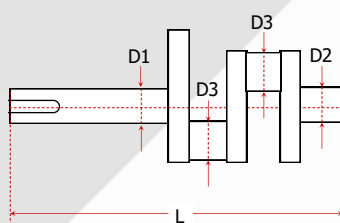

TRC05

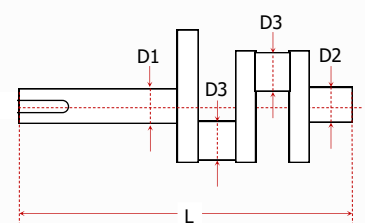

TRC06

*No tiene rosca para centrifugo.

*No tiene rosca para centrifugo.

PARTES PARA CABEZAL

Air pump spare parts

STARLINE
air compressor

PISTÓN
PISTÓN

MODELO	DIMENSIONES			MATERIAL	APTO PARA CABEZAL	PIEZAS
	Ø	A	D1			
TRP01	51	50	12.3	ALUMINIO	TB10S, TB20S	1
TRP02	55	82.5	18.6	Fo. Fo.	(ALTA) TX50C, TX100S	1
TRP03	65	50	14.2	ALUMINIO	TB03S, TB30S	1
TRP04	80	62.5	14.7	ALUMINIO	TB50S	1
TRP05	105	82.5	18.5	ALUMINIO	(BAJA) TX50C, TX100S	1

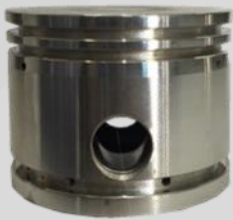

TRP01



TRP02



TRP03



TRP04

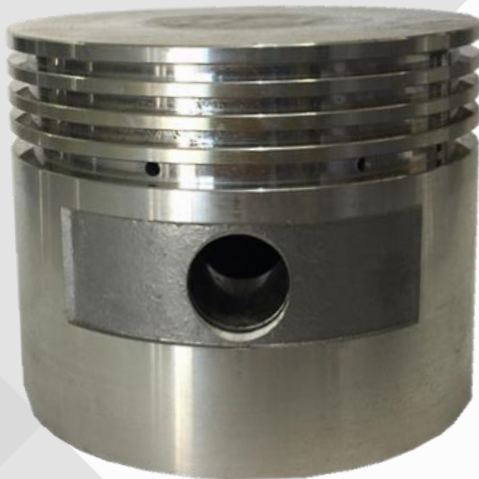

TRP05

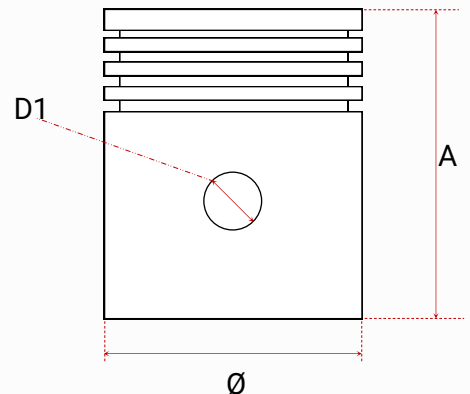

*No incluyen anillos, perno ni seguros.

PARTES PARA CABEZAL

STARLINE
air compressor

PISTON RINGS

ANILLOS PARA PISTÓN

MODELO	Ø	APTO PARA CABEZAL	PIEZAS
TRA01	51 mm.	TB10S, TB20S	1 JUEGO CON 3 PIEZAS
TRA02	55 mm.	(ALTA) TX50C, TX100S	1 JUEGO CON 4 PIEZAS
TRA03	65 mm.	TB03S, TB30S	1 JUEGO CON 3 PIEZAS
TRA04	80 mm.	TB50S	1 JUEGO CON 3 PIEZAS
TRA05	105 mm.	(BAJA) TX50C, TX100S	1 JUEGO CON 4 PIEZAS
TRA25	55 y 105 mm.	1 TRA02 (ALTA) Y 1 TRA05 (BAJA)	1 JUEGO CON 8 PIEZAS

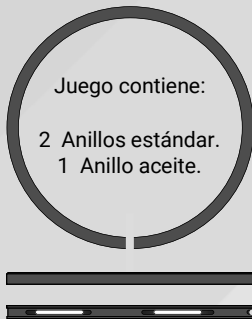

TRA01

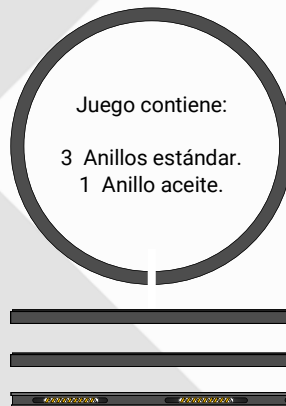

TRA02

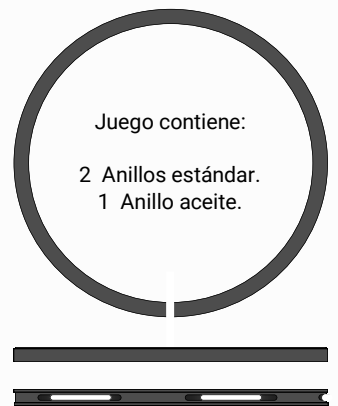

TRA03

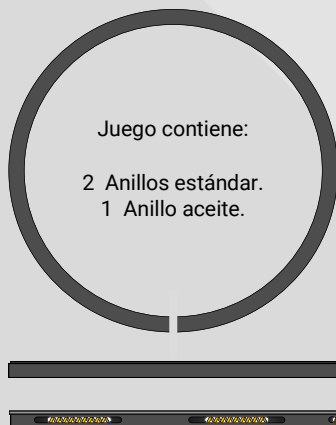

TRA04

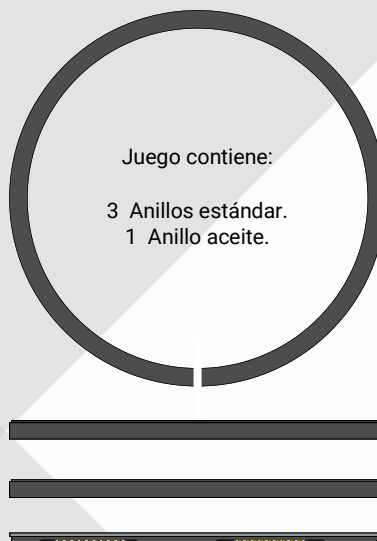

TRA05

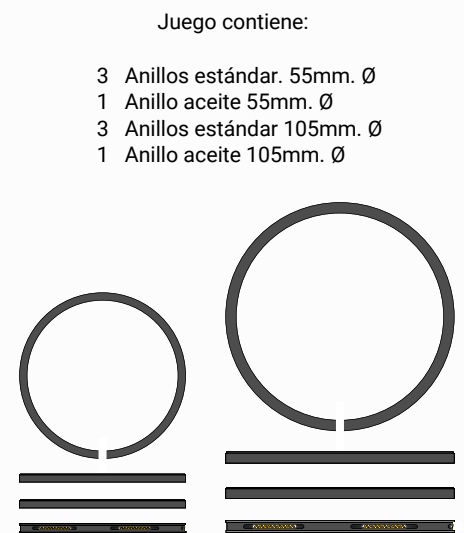

TRA25

PARTES PARA CABEZAL

STARLINE
air compressor

BEARINGS BUSH
METALES

MODELO	DIMENSIONES		MATERIAL	APTO PARA CABEZAL	PIEZAS
	D	H			
TRX01	40 mm.	24 mm.	ALUMINIO	TX50C, TX100S	1 PAR
TRX01-4P	40 mm.	24 mm.	ALUMINIO	TX50C, TX100S	4 PARES



TRX01



TRX01-4P

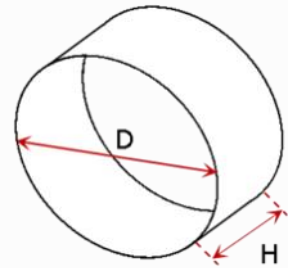

PISTON PIN **PERNO**

MODELO	DIMENSIONES		MATERIAL	COMPATIBLE CON		PIEZAS
	D	L		BIELA	PISTON	
TRK01	12.7mm.	43 mm.	ACERO	TRB01, TRB02, TRB03	TRP03	1
TRK02	19 mm.	45 mm.	ACERO	TRB06	TRP02	1
TRK03	14.5 mm.	51.5 mm.	ACERO	TRB04, TRB07	TRP03	1
TRK05	19 mm.	95 mm.	ACERO	TRB06	TRP05	1
TRK25	19 mm.	45 mm. y 95 mm.	ACERO	TRB06	TRP02 + TRP05	1 TRK02 y 1 TRK05



TRK01, TRK02,
TRK03, TRK05



TRK25

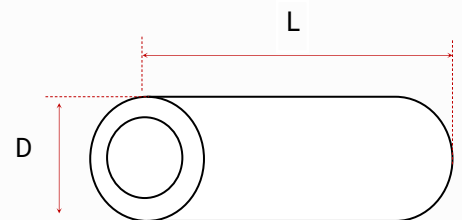

PARTES PARA CABEZAL

Air pump spare parts

STARLINE
air compressor

BEARING
BALERO

MODELO	CODIGO	APTO PARA CABEZAL	PIEZAS
TRF01	6004	TB03S	1
TRF02	6204	TB03S, TB10S	1
TRF03	6205	TB10S, TB20S, TB30S	1
TRF04	6304	TB20S, TB30S, TB50S	1
TRF05	6307	TB50S	1
TRF06	32208	TX50C, TX100S	1
TRF07	30307	TX50C, TX100S	1

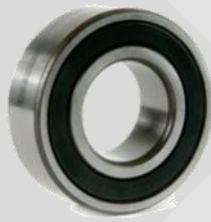

TRF01, TRF02, TRF03,
TRF04, TRF05



TRF06, TRF07

OIL SEAL **RETEN**

MODELO	CODIGO		APTO PARA CABEZAL	PIEZAS
	Ø INTERIOR	Ø EXTERIOR		
TRS01	40	65	TX50C, TX100S	1
TRS02	20	36	TB03S	1
TRS03	20	40	TB10S	1
TRS04	24	47	TB20S, TB30S	1
TRS05	35	56	TB50S	1



TODOS

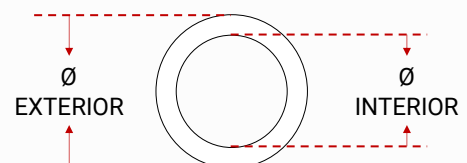

PARTES PARA CABEZAL

Air pump spare parts

STARLINE
air compressor

VALVE BLOCK
VÁLVULA FLAPPER

MODELO	MATERIAL	APTO PARA CABEZAL	PIEZAS
TRL01	METAL	TB03S, TB30S	1
			25
			50
TRL02	METAL	TB02S, TB10S, TB20S	1
			25
			50
TRL03	METAL	ALGUNOS MODELOS TH55S, AT40S, TB50S	1
			25
			50
TRL04	METAL	ALGUNOS MODELOS TH55S, AT40S, TB50S	1
			25
			50
TRL09	METAL	ULA10	1
			25
			50
TRL14	METAL	ULA20	1
			25
			50
TRL66	METAL	MOTOCOMPRESORES	1
			25
			50



TRL01



TRL02

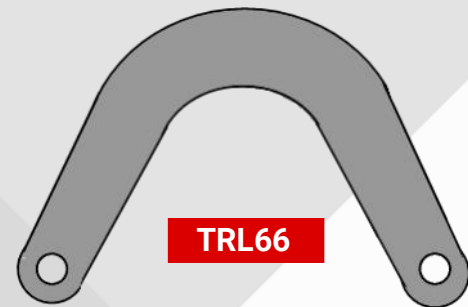

TRL66



TRL09



TRL03

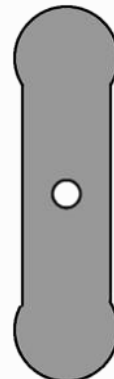

TRL14

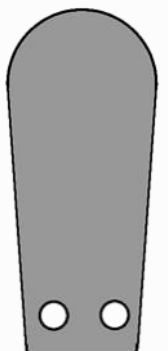

TRL04

PARTES PARA CABEZAL

Air pump spare parts

STARLINE
air compressor

INLET & EXHAUST VALVE SEAT VÁLVULA DE ADMISIÓN Y ESCAPE

MODELO	TIPO	APTO PARA CABEZAL	PIEZAS
TRH01	ADMISIÓN	TX50C, TX100S	1
TRH02	ESCAPE	TX50C, TX100S	1
TRH23	JUEGO 5 PZS.	TX50C, TX100S	2 TRH01 + 3 TRH02



TRH01



TRH02



TRH23

CILINDER COVER TAPA DE CILINDRO

MODELO	MATERIAL	APTO PARA CABEZAL	PIEZAS
TRZ01	ALUMINIO	TB10S, TB20S	1
TRZ02	ALUMINIO	TB03S, TB30S	1
TRZ03	Fo. Fo.	TB50S	1
TRZ04	Fo. Fo.	TX50C, TX100S IZQ.	1
TRZ05	Fo. Fo.	TX100CSL DER.	1



TRZ01, TRZ02, TRZ03



TRZ04



TRZ05

PARTES PARA CABEZAL

Air pump spare parts

STARLINE
air compressor

INLET AIR FILTER FILTRO DE ADMISIÓN

MODELO	ROSCA	MATERIAL	INTERIOR	APTO PARA CABEZAL	PIEZAS
AFB38	3/8"	PLASTICO	ESPONJA	LIBRE ACEITE/MOTOCOMP.	1
AFB39	1/4"	LAMINA	ELEMENTO	LIBRES DE ACEITE	1
AFB40	3/8"	LAMINA	ELEMENTO	LIBRE ACEITE/MOTOCOMP.	1
AFB03					1
AFB03-10P	1/2"	PLASTICO	ESPONJA	TB03S, TB10S, TB20S, TB30S	10
AFB03-50P					50
AFB10					1
AFB10-10P	1/2"	PLASTICO	ELEMENTO	TB03S, TB10S, TB20S, TB30S	10
AFB10-50P					50
AFT40	3/4"	PLASTICO	ELEMENTO	AT40S, TH30S, TB50S	1
AFB13	TORNILLOS (NO INCLUIDOS)	PLASTICO	ESPONJA	ALGUNOS TH10, TH20	1
AFX50	1"	LAMINA	ELEMENTO	TX50C, TX100S	1
AFX50-10P					10
AFA14	1/4"	ALUMINIO	DELCRON	VARIOS	1
AFA38	3/8"	ALUMINIO	DELCRON	VARIOS	1
AFA12	1/2"	ALUMINIO	DELCRON	VARIOS	1
AFA34	3/4"	ALUMINIO	DELCRON	VARIOS	1



AFB38



AFB39, AFB40



AFB03



AFB10



AFT40



AFA14, AFA38,
AFA12, AFA34



AFX50



AFB13

PARTES PARA CABEZAL

Air pump spare parts

STARLINE
air compressor

MANN-FILTER AIR FILTER ELEMENTO FILTRANTE

MODELO	DIMENSIONES			MATERIAL	APTO PARA FILTRO	PIEZAS
	D. int	D. ext	Alt.			
AFE01	42mm	67 mm	41 mm	CARTON/LAMINA	AFB10	1
AFE01-10P						10
AFE02	42mm	67 mm	52 mm	CARTON/LAMINA	AFT40	1
AFE02-10P						10
AFE03	74mm	108 mm	53 mm	CARTON/LAMINA	AFX50	1
AFE03-10P						10



AFE01



AFE02



AFE03

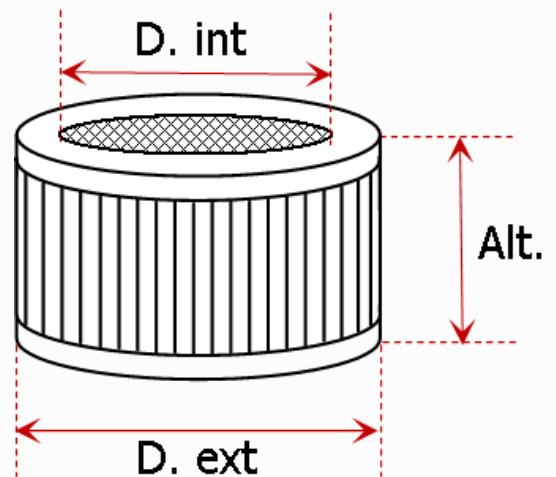

PARTES PARA CABEZAL

Air pump spare parts

STARLINE
air compressor

OIL LEVEL SIGHT GLASS **MIRILLA DE ACEITE**

MODELO	ENTRADA	MATERIAL	APTO PARA CABEZAL	PIEZAS
TRM01	1/2"	PLASTICO	TB03S, TB10S, TB20S, TB30S	1
TRM01-10P				10
TRM02	1/2"	METAL	TB03S, TB10S, TB20S, TB30S	1
TRM02-10P				10
TRM03	3/4"	METAL	TB40S, AT40S, TB50S, TX50C, TX100S	1
TRM03-10P				10
TRM04	TORNILLOS (NO INCLUIDOS)	Fo. Fo.	TX50C, TX100S	1
TRM04-10P				10



TRM01



TRM02



TRM03



TRM04

* Las imágenes pueden variar en color o apariencia.

PARTES PARA CABEZAL

Air pump spare parts

STARLINE
air compressor

OIL FILLING PLUG
TAPÓN DE ACEITE

MODELO	MATERIAL	APTO PARA CABEZAL	PIEZAS
TRT01	PLASTICO	TB03S, TB10S	1
TRT01-10P			10
TRT02	PLASTICO	TB10S, TB20S, TB30S, TB40S, AT40S, y TB50S	1
TRT02-10P			10
TRT03	METAL	TX50C, TX100S	1
TRT03-10P			10



TRT01



TRT02



TRT03

PARTES PARA CABEZAL

Air pump spare parts



BREATH PIPE RESPIRADERO

MODELO	MATERIAL	APTO PARA CABEZAL	PIEZAS
TRR01	PLASTICO	ALGUNOS MODELOS DE TB20S, TB30S	1
TRR01-10P			10
TRR02	PLASTICO	ROSCA 3/8", TODOS LOS MODELOS	1
TRR02-10P			10
TRR03	PLASTICO	ROSCA ESPECIAL, ALGUNOS MODELOS	1
TRR03-10P			10
TRR04	METAL	ROSCA 3/8", TODOS LOS MODELOS	1
TRR04-10P			10
TRR05	PLASTICO	MOTOCOMPRESORES	1
TRR05-10P			10
TRR06	METAL	ROSCA 1/4", TX50C, TX100S	1
TRR07	PLASTICO	ROSCA 1/4", TX50C, TX100S	1
TRR07-10P			10



TRR01



TRR02



TRR03



TRR04



TRR05



TRR06



TRR07

* Las imágenes pueden variar en color o apariencia.

PARTES PARA CABEZAL

Air pump spare parts

STARLINE
air compressor

GASKET KIT

EMPAQUES PARA CABEZALES "TB"

MODELO	MATERIAL	APTO PARA CABEZAL	PIEZAS
TRJ01	METAL/ ASBESTO	TB02S, CILINDRO DE TB10S o TB20s	1
TRJ01-10P			10 JUEGOS
TRJ02	METAL/ ASBESTO	TB03S, CILINDRO DE TB30S	1
TRJ02-10P			10 JUEGOS
TRJ03	METAL/ ASBESTO	TB10S, TB20S	1
TRJ03-10P			10 JUEGOS
TRJ04	METAL/ ASBESTO	TB30S	1
TRJ04-10P			10 JUEGOS

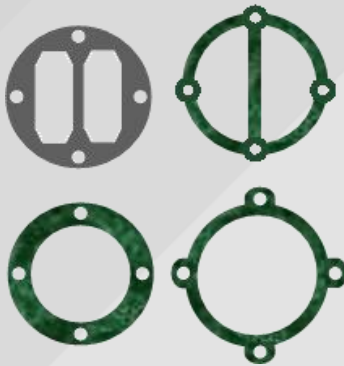

TRJ01

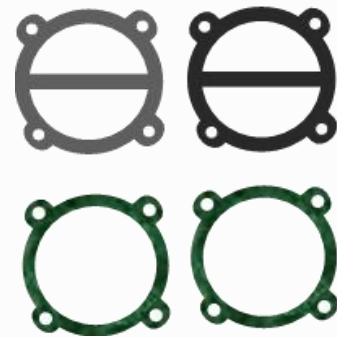

TRJ02

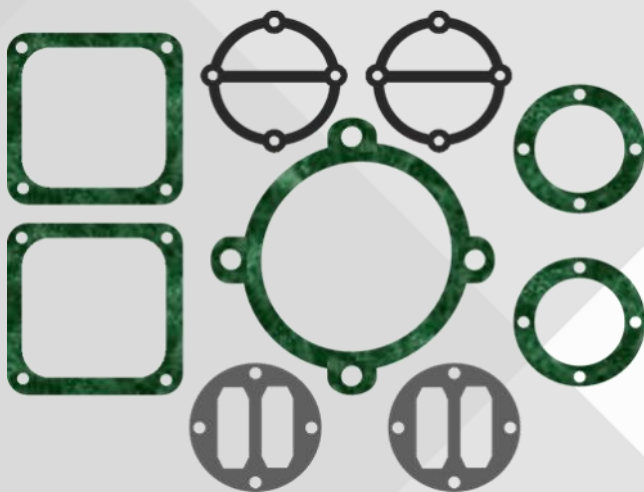

TRJ03

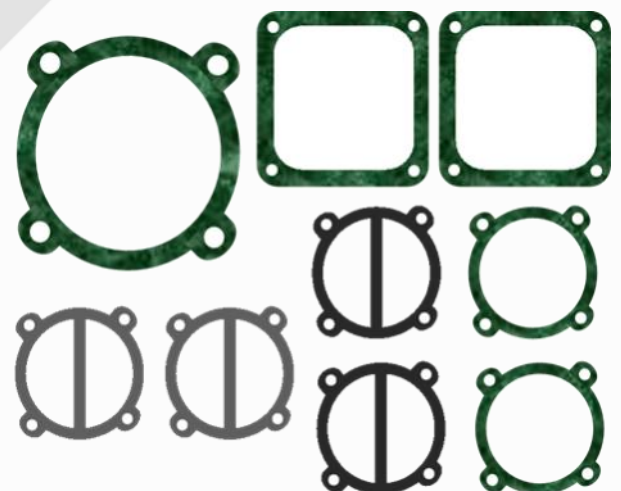

TRJ04

PARTES PARA CABEZAL

Air pump spare parts

STARLINE
air compressor

GASKET KIT

EMPAQUES PARA CABEZALES "TX"

MODELO	MATERIAL	APTO PARA CABEZAL	PIEZAS
TRJ09	METAL/ ASBESTO	TX50C	1 JUEGO
TRJ09-10P			10 JUEGOS
TRJ13	METAL/ ASBESTO	TX100S	1 JUEGO
TRJ13-10P			10 JUEGOS

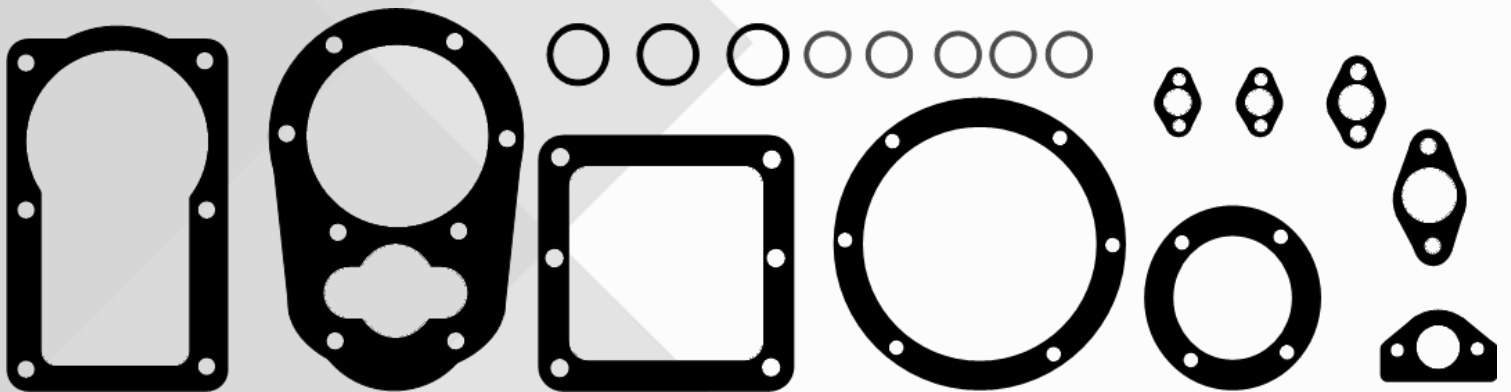

TRJ09

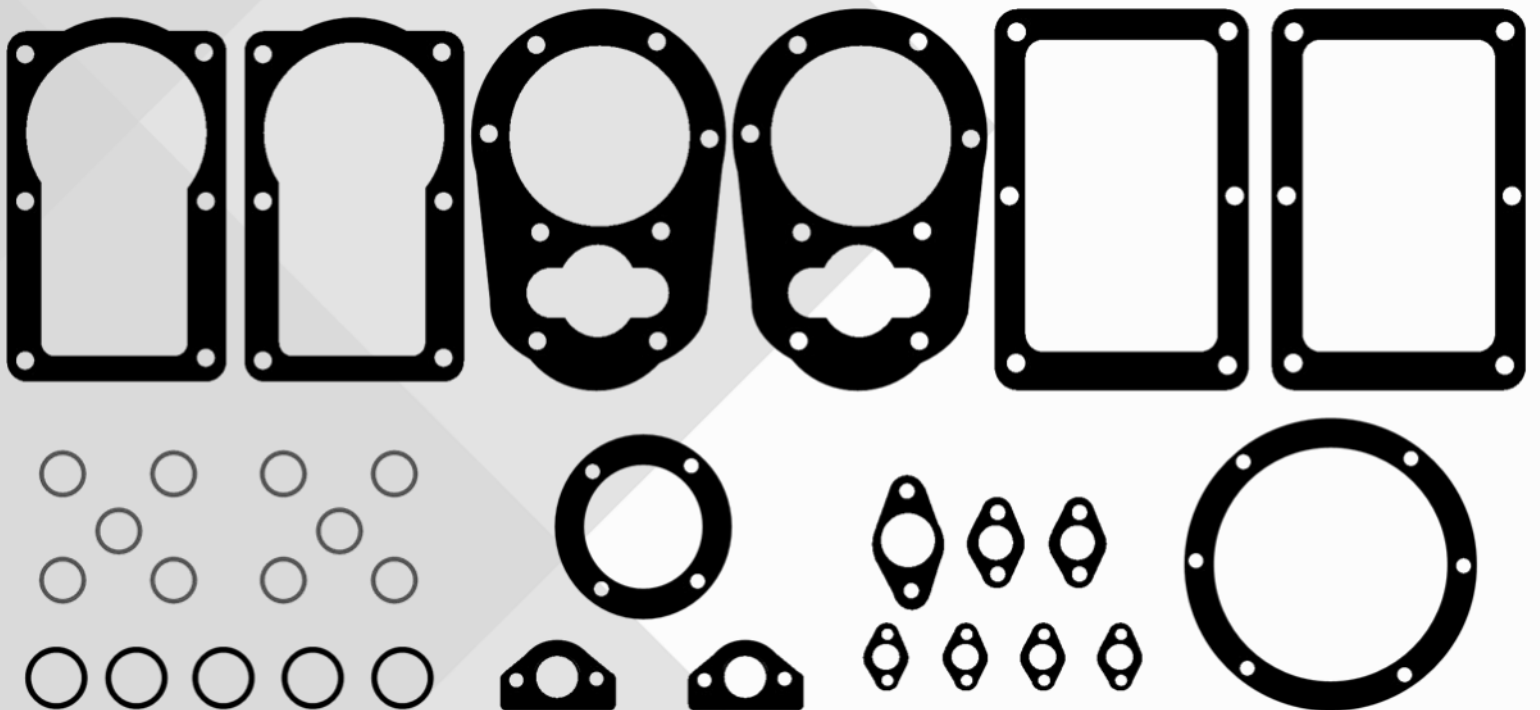

TRJ13

PARTES PARA CABEZAL

Air pump spare parts

STARLINE
air compressor

FLYWHEEL

VOLANTE PARA CABEZAL

MODELO	DIMENSIONES		RANURA		APTO PARA CABEZAL	PIEZAS
	D	H	Num.	TIPO		
TRV11	6"	1.3"	1	A	TB03S	1
TRV01	7"	1.3"	1	A	TB03S	1
TRV02	10.5"	1.47"	1	A	TB10S	1
TRV03	10.5"	1.73"	1	A	TB20S, TB30S	1
TRV04	14"	2"	2	B	TB50S	1
TRV05	17"	2.85"	2	B	TX50C	1
TRV06	19"	2.86"	2	B	TX100S	1



TRV11, TRV01



TRV02, TRV03, TRV04



TRV05, TRV06

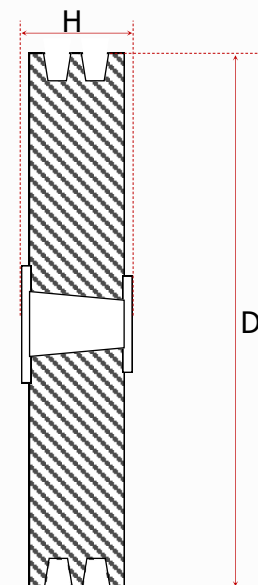

PARTES PARA CABEZAL

Air pump spare parts

STARLINE
air compressor

COOLING PIPE

TUBO DE ENFRIAMIENTO

MODELO	LARGO	TUERCAS	APTO PARA CABEZAL	PIEZAS
TRQ01	24 cm.	1/2" FLARE	TB10S, TB20S, TB30S, TB40S	1



TRQ01

THROUGH RELIEF VALVE
VÁLVULA DE DESAHOGO

MODELO	ENTRADA	MATERIAL	APTO PARA CABEZAL	PIEZAS
TRD01	1/8" cm.	BRONCE	TX50C, TX100S	1



TRD01

Conoce todos **nuestros**

Productos

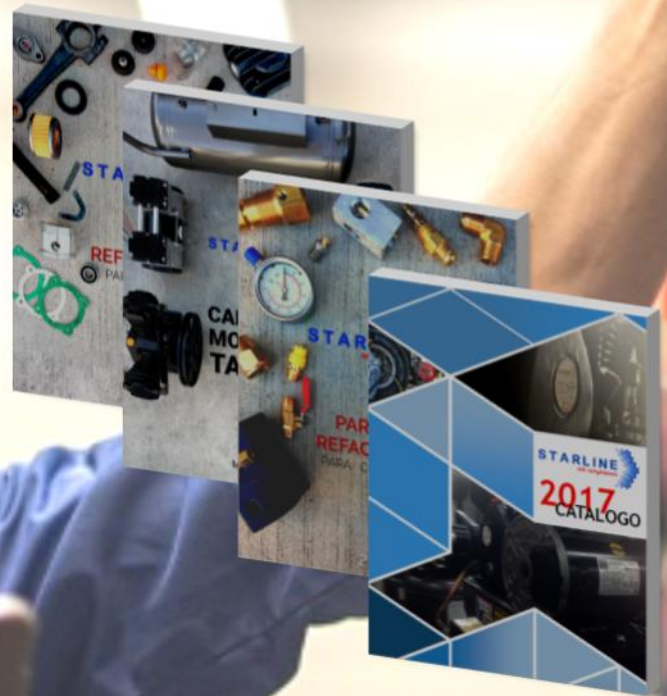

Y visualízalos desde tu
tablet, móvil o PC
cuando y donde tú quieras

descargando los catálogos en
www.starline.com.mx

STARLINE
air compressor



Starline air compressor, S.A. de C.V.

Jose Sixto Verduzco No. 83, Col. El retiro,

C.P.: 44280, Guadalajara, Jal. México

Tel.: +52 (33) 3613 9948, ventas@starline.com.mx

www.starline.com.mx